

IGBT MOSFET driver power supply

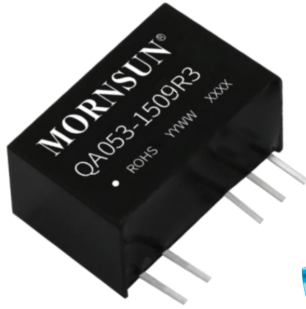

RoHS
 US
 UL62368-1
 Report
 EN62368-1

FEATURES

- Reinforced insulation
- I/O isolation test voltage: 5000VAC
- Continuous barrier withstand voltage 1700V
- Characterised CMTI>200kV/μs
- Max. Capacitive Load: 2200μF
- High efficiency up to 87%
- SIP package
- Ultra-low isolation capacitance: 3.5pF (typ.)
- Operating ambient temperature range: -40°C to +105°C
- Continuous short-circuit protection

QAxx3-R3 is DC-DC module power supply designed for IGBT driver requiring two sets of isolation power supply. The mode of common ground outputs is adopted internally for better energy provision of IGBT turn-on and turn-off. Output short-circuit protection and self-recovery capabilities are also provided. General application includes:

1. Universal converter
2. AC servo drive system
3. Electric welding machine
4. Uninterruptible power supply (UPS)

Selection Guide

Certification	Part No	Input		Output		Full Load Efficiency (%) Typ.	Max. Capacitive Load(μF)
		Voltage(VDC) (Range)	Current(mA, Typ.) Full Load/No Load	Voltage (VDC) +Vo1/+Vo2	Current (mA) +Io1/+Io2		
UL/EN	QA053-1509R3	5 (4.5-5.5)	382/62	+15.0/-8.7	+80/-40	78/82	1000
	QA123-1509R3	12 (10.8-13.2)	242/8	+15.0/-9.0	+100/-100	82/87	2200
	QAW123-1509R3	12 (9-15)	242/8				
	QA153-1509R3	15 (13.5-16.5)	195/8				
	QA243-1509R3	24 (21.6-26.4)	135/9				

Note:*The specified maximum capacitive load for positive and negative output is identical.

Input Specifications

Item		Operating Conditions		Min.	Typ.	Max.	Unit
Input Voltage (1sec. max.)	Vin=5VDC	DC		-0.7	--	9	VDC
	Vin=12VDC	DC		-0.7	--	18	
	Vin=15VDC	DC		-0.7	--	21	
	Vin=24VDC	DC		-0.7	--	30	
Input Filter				Capacitance Filter			
Hot Plug				Unavailable			

Output Specifications

Item		Operating Conditions		Min.	Typ.	Max.	Unit		
Output Voltage	QA053-1509R3	+Vo	Vin=5VDC, Pin6 & Pin7 +Io= +80mA	14.55	15.3	16.05	VDC		
		-Vo	Vin=5VDC, Pin5 & Pin6 -Io= -40mA	-8.32	-8.76	-9.20			
	QA123-1509R3	+Vo	Vin=12VDC, Pin6 & Pin7 +Io= +100mA	13.50	14.25	15.00			
		-Vo	Vin=12VDC, Pin5 & Pin6 -Io= -100mA	-7.92	-8.37	-8.82			
	QAW123-1509R3	+Vo	Vin=12VDC, Pin6 & Pin7 +Io= +100mA	13.50	14.25	15.00			
		-Vo	Vin=12VDC, Pin5 & Pin6 -Io= -100mA	-7.92	-8.37	-8.82			
	QA153-1509R3	+Vo	Vin=15VDC, Pin6 & Pin7 +Io= +100mA	14.25	15.00	15.75			
		-Vo	Vin=15VDC, Pin5 & Pin6 -Io= -100mA	-7.92	-8.37	-8.82			
	QA243-1509R3	+Vo	Vin=24VDC, Pin6 & Pin7 +Io= +100mA	14.55	15.30	16.05			
		-Vo	Vin=24VDC, Pin5 & Pin6 -Io= -100mA	-8.37	-8.82	-9.27			
	Voltage Accuracy		10% - 100% load		See output regulation curve (Fig. 2- Fig. 9)				
	Linear Regulation	5V Input model	Full voltage input range	+Vo Output	--	±1.1		±1.4	--
-Vo Output				--	±1.1	±1.4			
Other model		+Vo Output		--	±1.1	±1.5			
		-Vo Output		--	±1.1	±1.5			
Load Regulation	5V Input model	10% - 100% load	+Vo Output	--	8	15	%		
			-Vo Output	--	10	15			
	Other model		+Vo Output	--	6	15			
			-Vo Output	--	8	15			
Temperature Coefficient		Full load		--	±0.04	±0.1	%/°C		
Ripple & Noise*	5V Input model	20MHz bandwidth		--	50	150	mVp-p		
	Other Input model			--	50	100			
Short-circuit Protection		Continuous, self-recovery							
Note:* The "parallel cable" method is used for Ripple and Noise test, please refer to DC-DC Converter Application Notes for specific information.									

General Specifications

Item	Operating Conditions	Min.	Typ.	Max.	Unit
Isolation	Input-output, Test for 1 minute with a leakage current of 1mA max	5000	--	--	VAC
Continuous barrier withstand voltage	Input- output (According to 61800-5-1)	1700	--	--	V
CMTI	Input- output	±200	--	--	kV/μs
Insulation Resistance	Input-output resistance at 500VDC	1000	--	--	MΩ
Isolation capacitor	Input- output, capacitor at 100kHz/0.1V	--	3.5	5	pF
Operating Temperature	Derating when operating temperature ≥85°C, (see Fig. 1)	-40	--	105	°C
Storage Temperature		-55	--	125	
Pin Soldering Resistance Temperature	Soldering spot is 1.5mm away from case for 10s seconds	--	--	300	
Case Temperature Rise	Ta=25°C, nominal input voltage, full load	--	30	60	
Storage Humidity	Non-condensing	5	--	95	
Switching Frequency	Full load, nominal input voltage	--	200	--	kHz
Safety Standard		UL62368-1 & EN62368-1 (Report)			
Safety Class		CLASS III			
MTBF	MIL-HDBK-217F@25°C	3500	--	--	k hours

Mechanical Specifications

Case Material	Black plastic; flame-retardant and heat-resistant
Dimensions	19.50 x 9.80 x 12.50mm
Weight	4.3g(Typ.)
Cooling Method	Free air convection

Electromagnetic Compatibility (EMC)

Emissions	CE	5V Input model	CISPR32/EN55032	CLASS B (see Fig. 17 for recommended circuit)
		Other Input model	CISPR32/EN55032	CLASS A (see Fig. 17 for recommended circuit)
	RE	5V Input model	CISPR32/EN55032	CLASS A (see Fig. 17 for recommended circuit)
		Other Input model	CISPR32/EN55032	CLASS B (see Fig. 18 for recommended circuit)
Immunity	ESD	5V Input model	IEC/EN61000-4-2	Contact ±6kV perf. Criteria B
		Other Input model	IEC/EN61000-4-2	Contact ±8kV perf. Criteria B

Typical Characteristic Curves

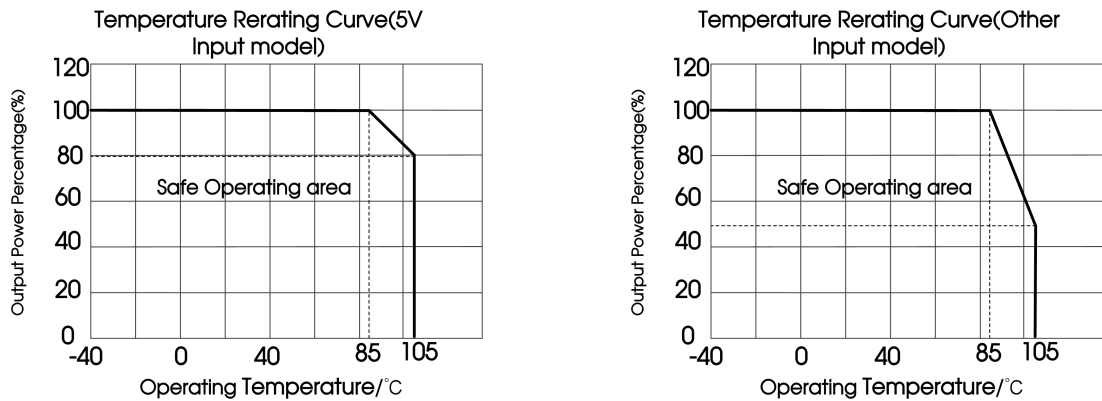

Fig. 1

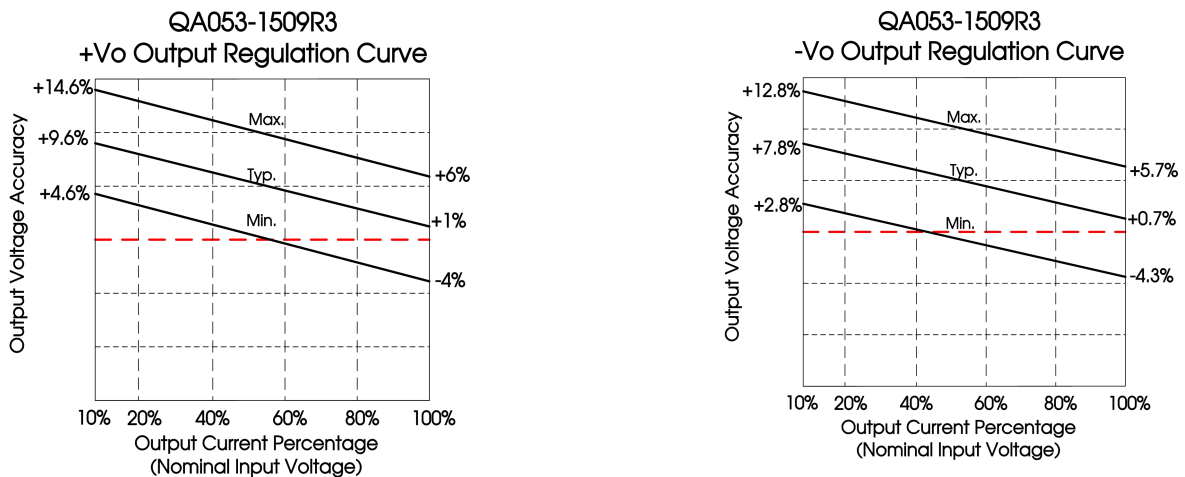

Fig. 2

Fig. 3

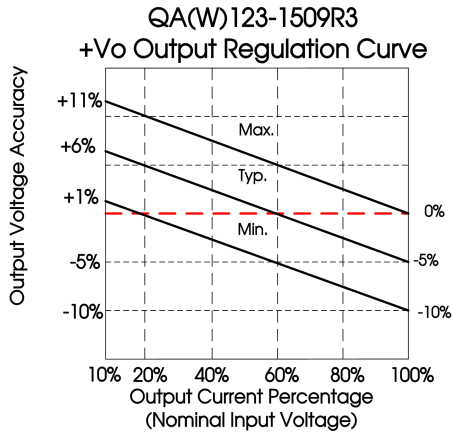

Fig. 4

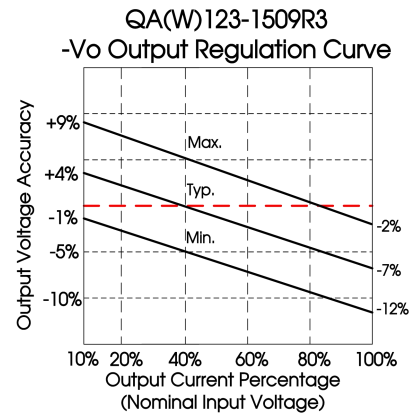

Fig. 5

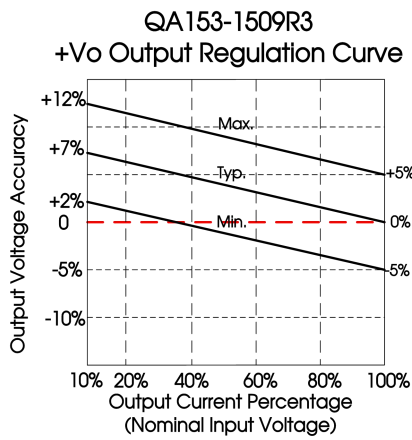

Fig. 6

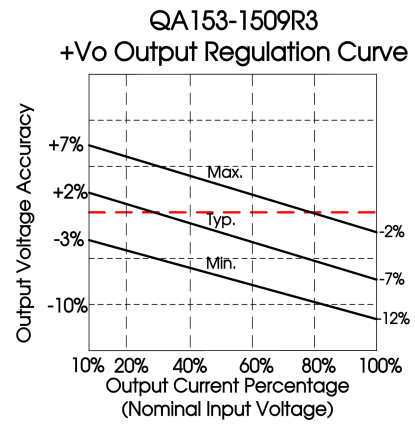

Fig. 7

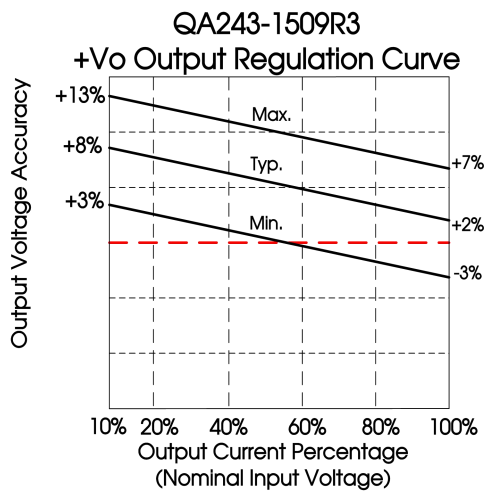

Fig. 8

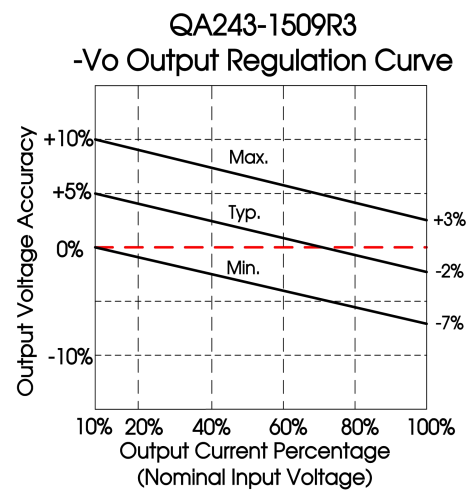

Fig. 9

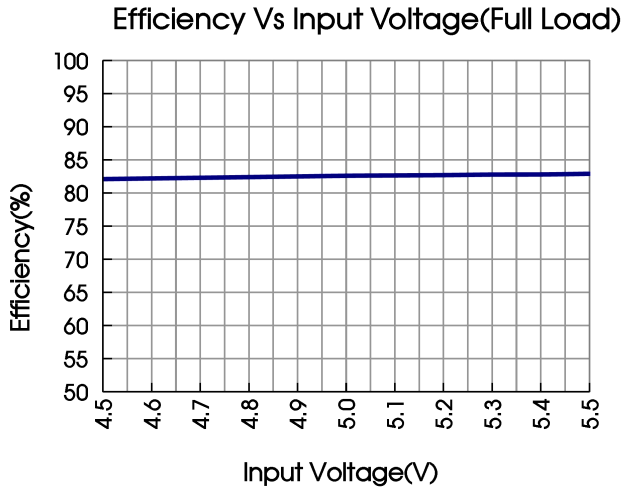

Fig. 10 (5V Input)

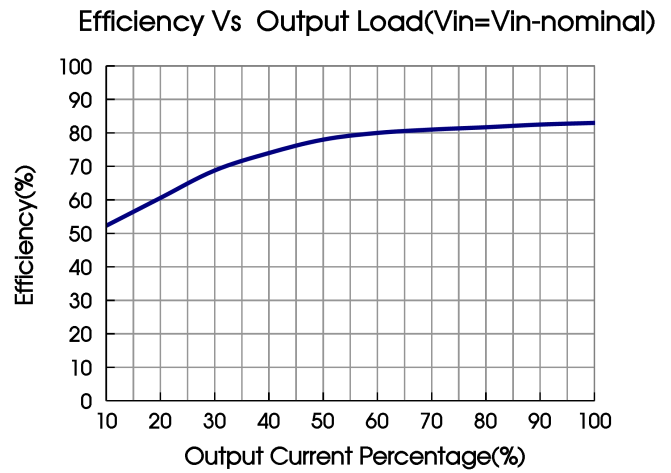

Fig.11 (5V Input)

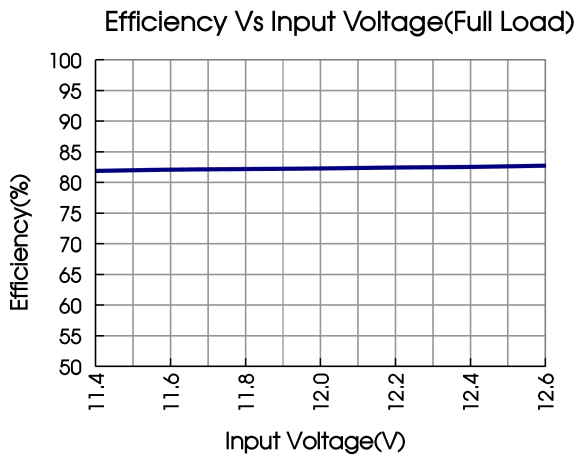

Fig. 12

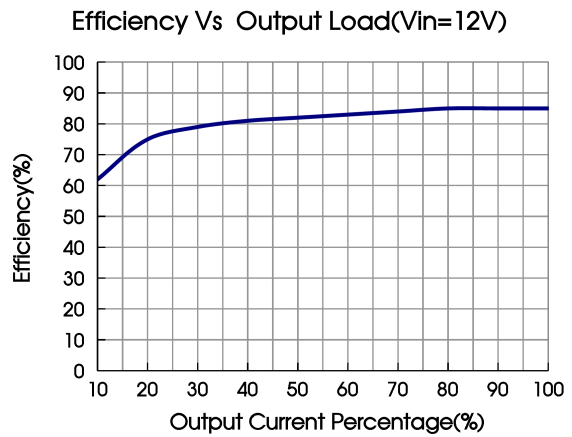

Fig. 13

Note: Take QA053-1509R3 and QA123-1509R3 as an example, other models can be corresponding reference

Design Reference

1. Test configurations

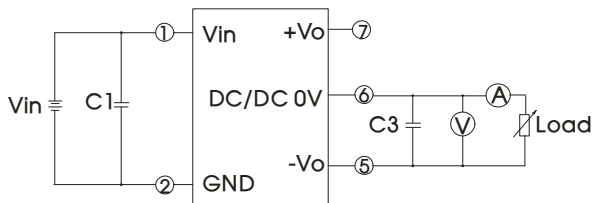

Fig. 14

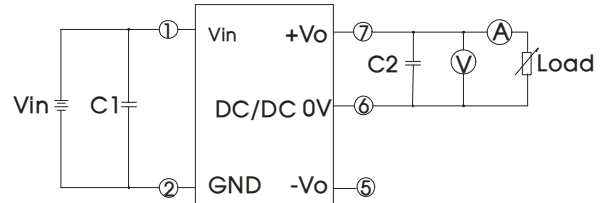

Fig.15

Note: C1, C2, C3: 100μF/35V(low resistors)

2. Typical application

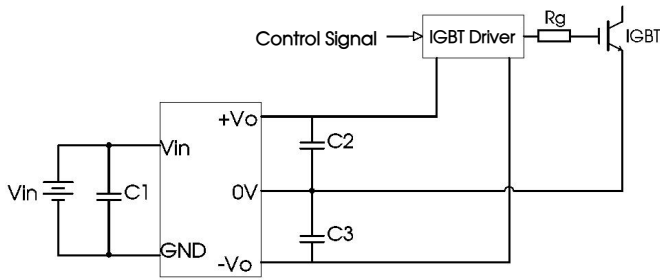

Fig. 16

C1/C2/C3
100μF/35V(Low internal resistance)

3. EMC typical recommended circuit (CLASS A)

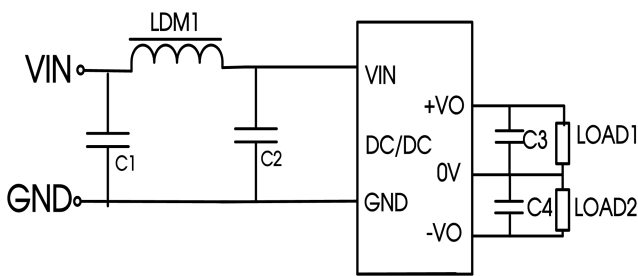

Fig. 17

Device selection			
Project	5V Input model	Other Input model	
EMI	C1/C2	4.7μF /16V	1μF/50V
	C3/C4	10μF /50V (Low internal resistance)	100μF/30V (Low internal resistance)
	LDM	6.8μH	33μH

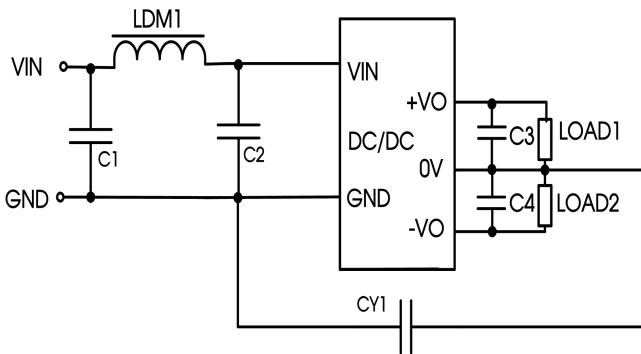

Fig. 18

Device selection (5V Input model)		
EMI	C1/C2	4.7μF /16V
	C3/C4	10μF /50V(Low internal resistance)
	LDM	6.8μH
	CY1	330pF

4. Electrolytic capacitors are recommended for external capacitors at the input or output of the product. Tantalum capacitors are not, otherwise there is a risk of failure.

5. The products do not support parallel connection of their output for power expansion purpose or hot-plug.

6. For more information please find the application notes on www.mornsun-power.com

Dimensions and Recommended Layout

THIRD ANGLE PROJECTION 

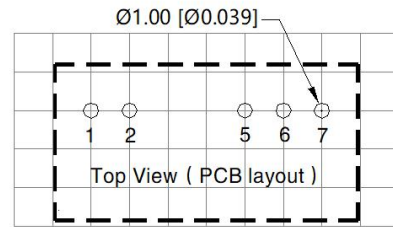
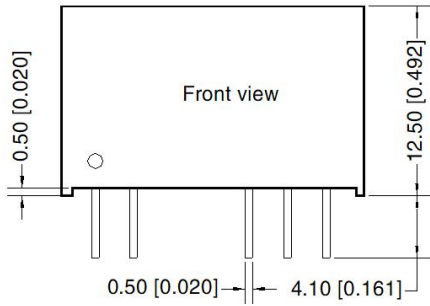

Note: Grid 2.54*2.54mm

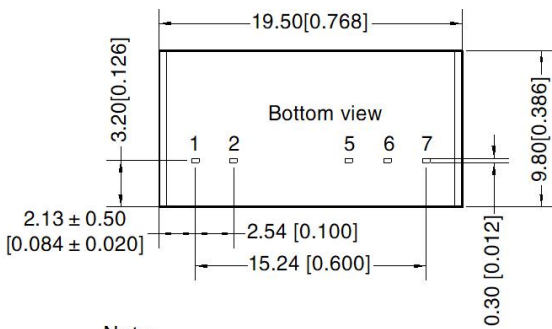

Note:
Unit: mm[inch]
Pin section tolerances: $\pm 0.10[\pm 0.004]$
General tolerances: $\pm 0.50[\pm 0.020]$

Pin-Out	
Pin	Mark
1	Vin
2	GND
5	-Vo
6	0V
7	+Vo

Notes:

1. For additional information on Product Packaging please refer to www.mornsun-power.com. Packaging bag number: 58200013;
2. The lead connecting the power supply module and IGBT driver should be as short as possible during use;
3. The output filtering capacitor should be as close as possible to the power supply module and IGBT driver;
4. The peak of the IGBT driver gate drive current is high, so low internal resistance electrolytic capacitor is recommended to be used for the power supply module output filter capacitor;
5. The average output power of the driver must be lower than that of the power supply module;
6. Consider fixing with glue near the module if being used in vibration occasion;
7. The maximum capacitive load offered were tested at nominal input voltage and full load;
8. Unless otherwise specified, parameters in this datasheet were measured under the conditions of $T_a=25^{\circ}\text{C}$, humidity<75%RH with nominal input voltage and rated output load;
9. All index testing methods in this datasheet are based on company corporate standards;
10. The above are the performance indicators of the product models listed in this datasheet. Some indicators of non-standard models will exceed the above requirements. For details, please contact our technical staff;
11. We can provide product customization service, please contact our technicians directly for specific information;
12. Products are related to laws and regulations: see "Features" and "EMC".
13. Our products shall be classified according to ISO14001 and related environmental laws and regulations, and shall be handled by qualified units

MORNSUN Guangzhou Science & Technology Co., Ltd.

Address: No. 5, Kehui St. 1, Kehui Development Center, Science Ave., Guangzhou Science City, Huangpu District, Guangzhou, P. R. China
Tel: 86-20-38601850 Fax: 86-20-38601272 E-mail: info@mornsun.cn www.mornsun-power.com